

Análisis sintáctico 1: Diagramas arbóreos

Workbook 6.3 (adaptado)

1. Tú y yo somos amigos excelentes.

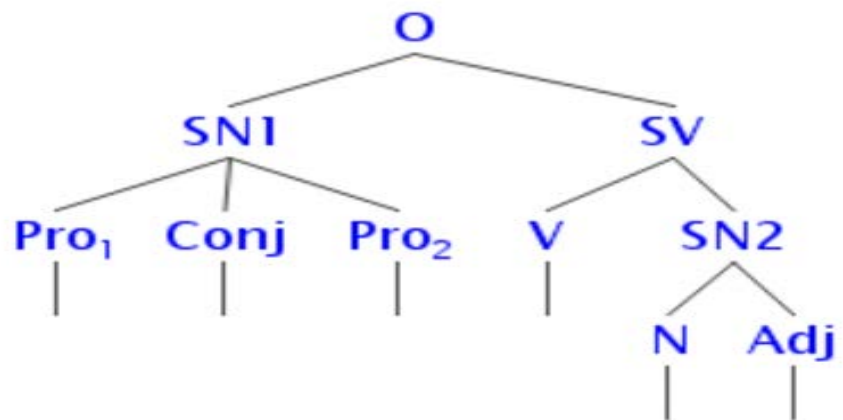
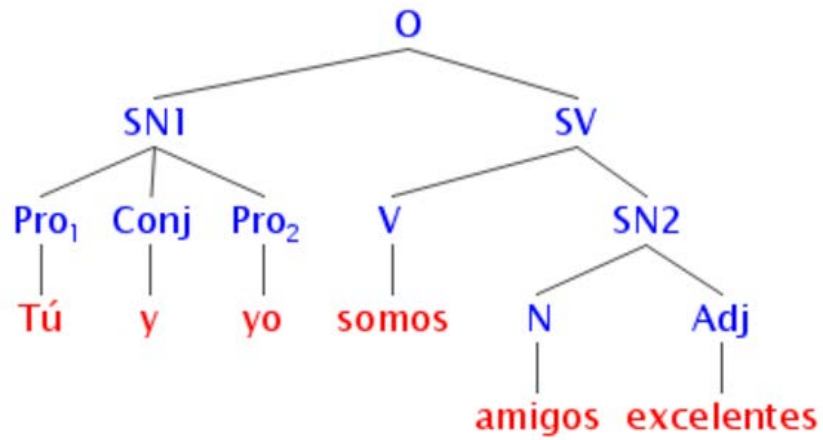

2. El lobo devoró a la abuela de Caperucita Roja.

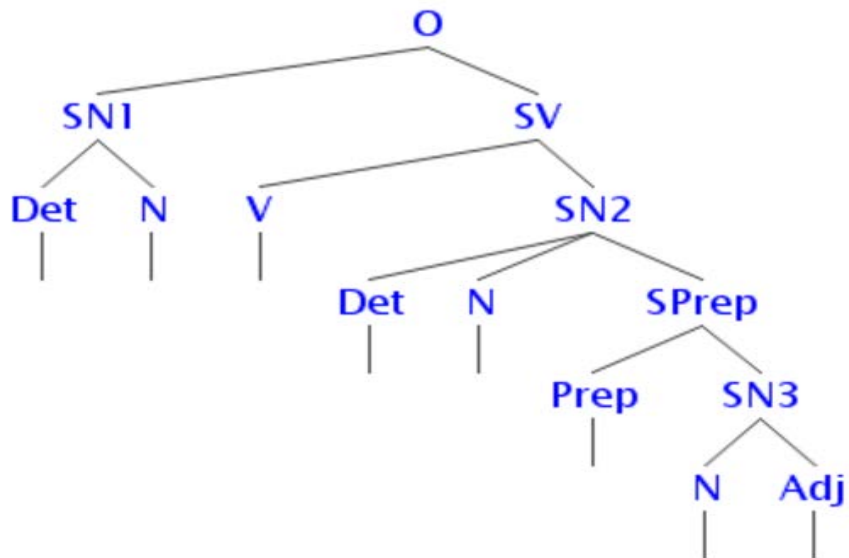
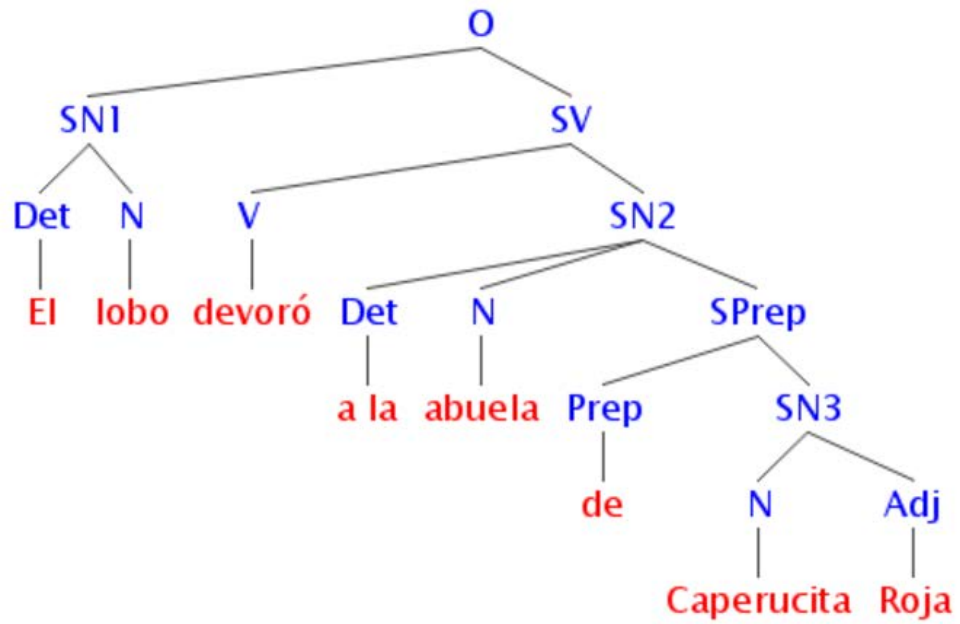

3. Ésta es mi casa nueva.

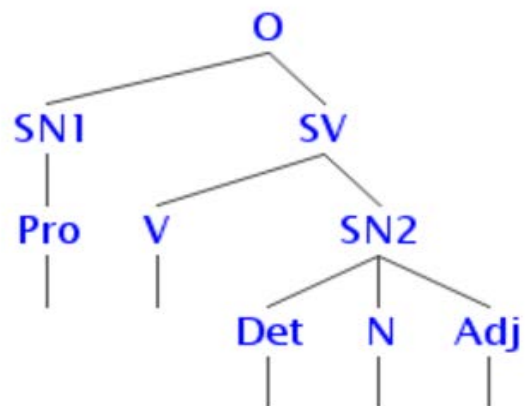
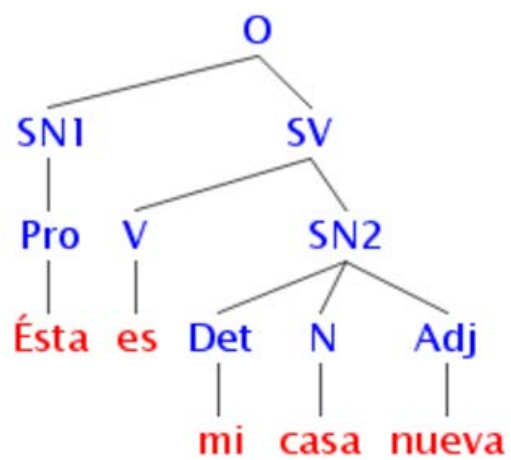

4. Los problemas de Paco y Lucía son tonterías.

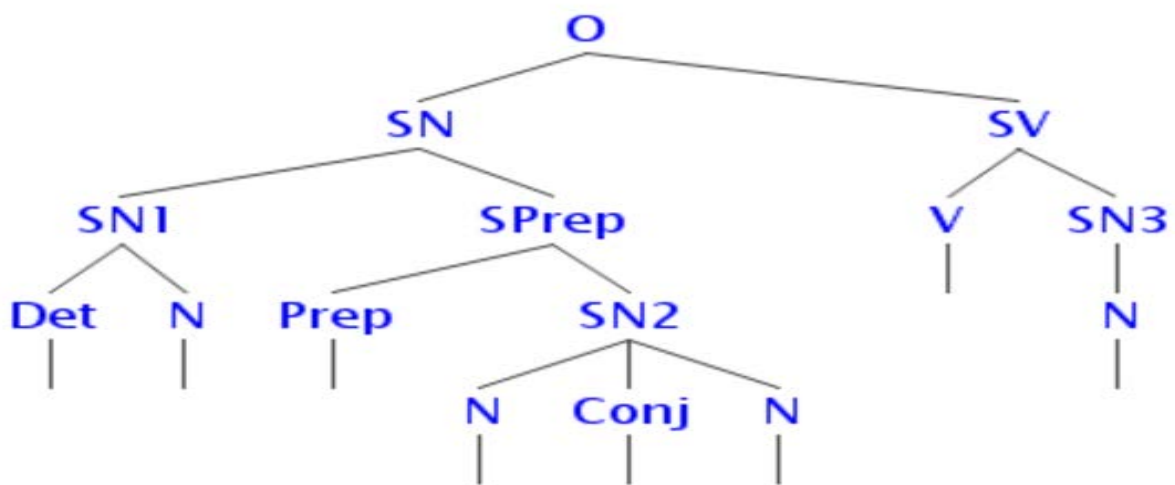
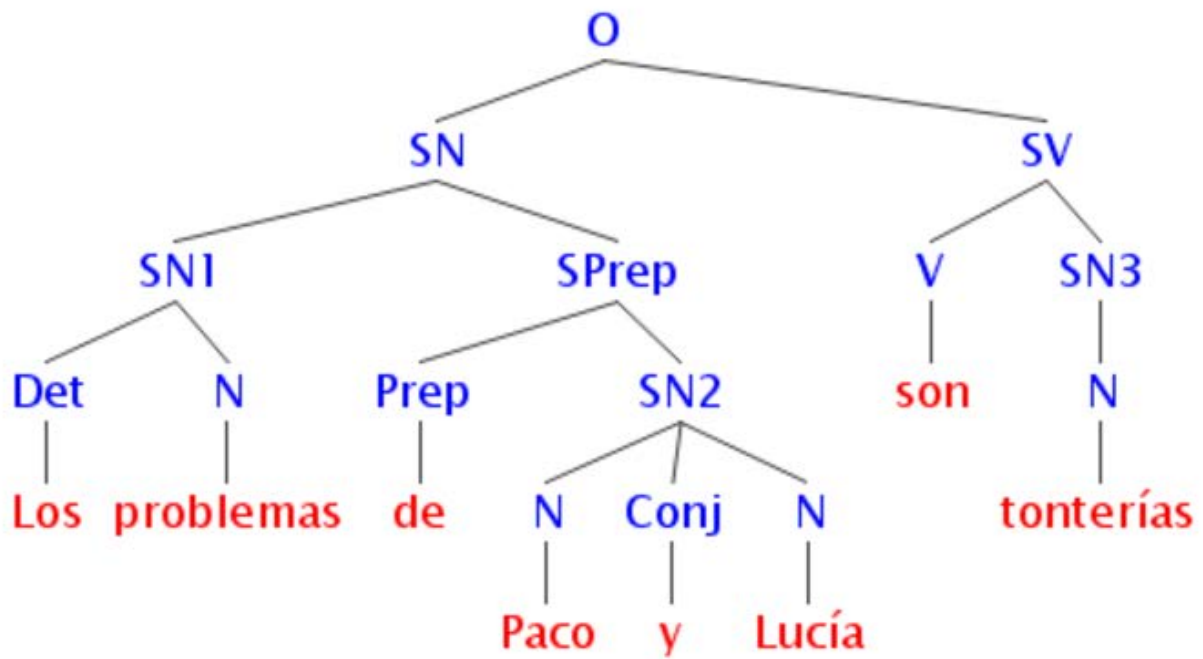

5. Todos iremos a la piscina mañana.

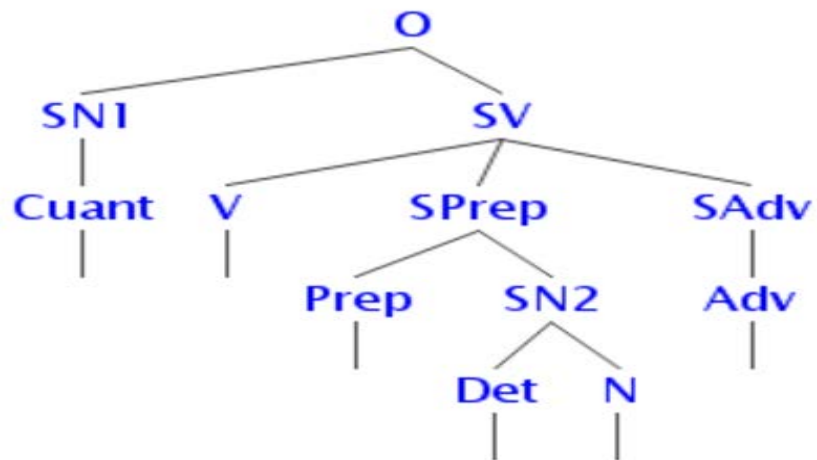
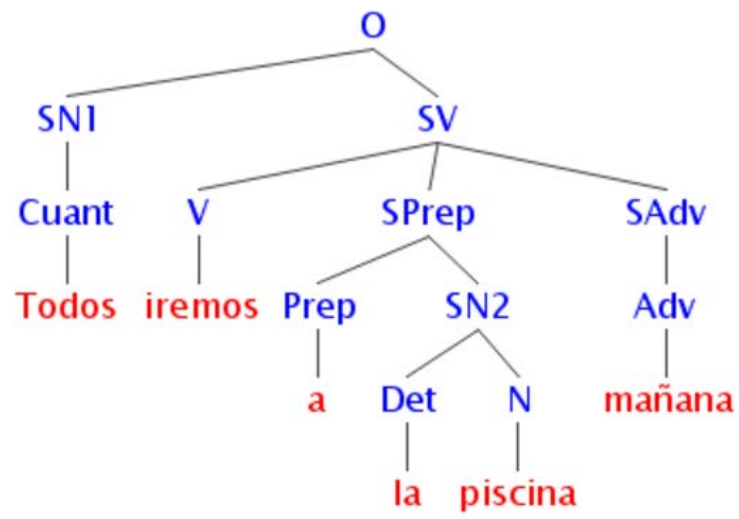

6. Ayer las preguntas del examen fueron fáciles.

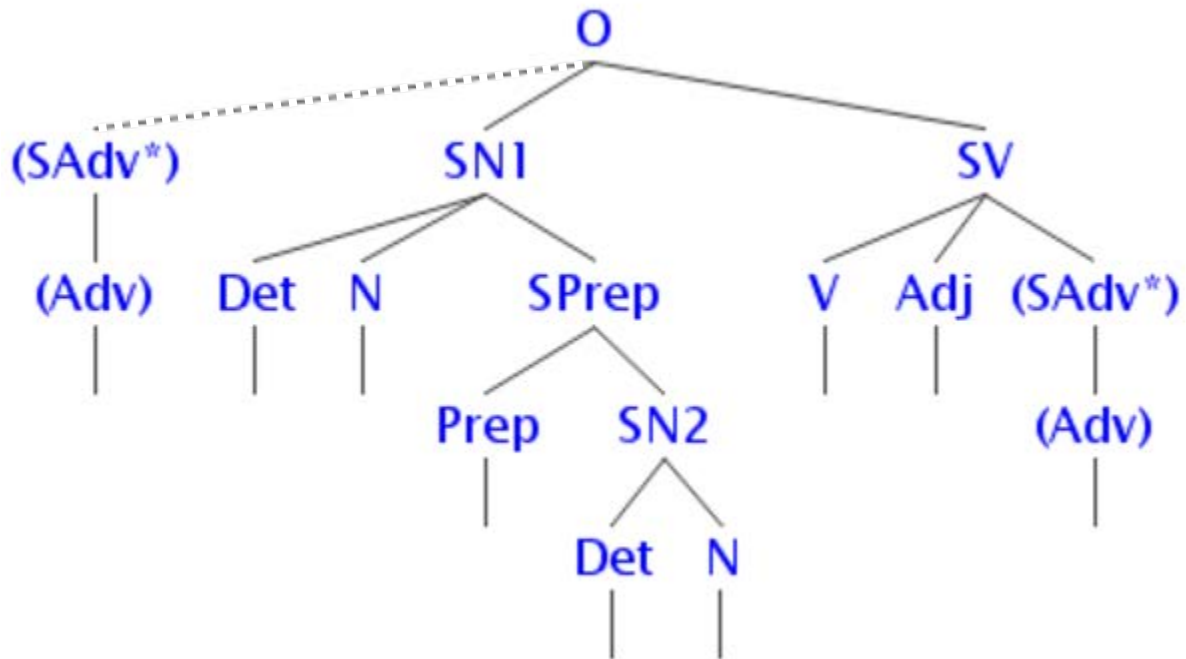
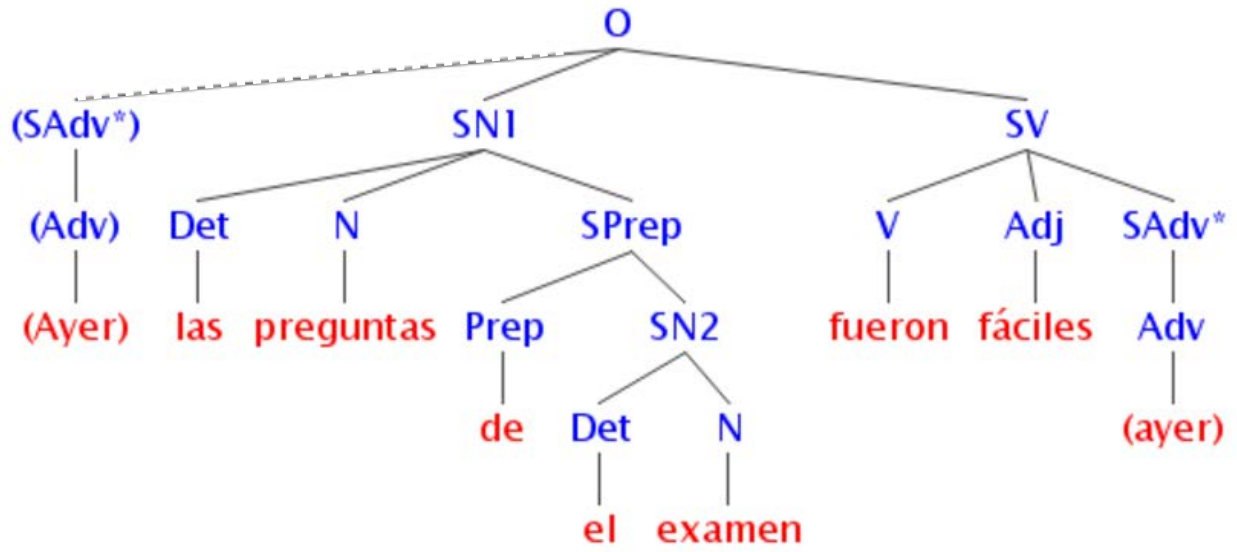

7. La niñera vigila atentamente a los niños pequeños desde la ventana.

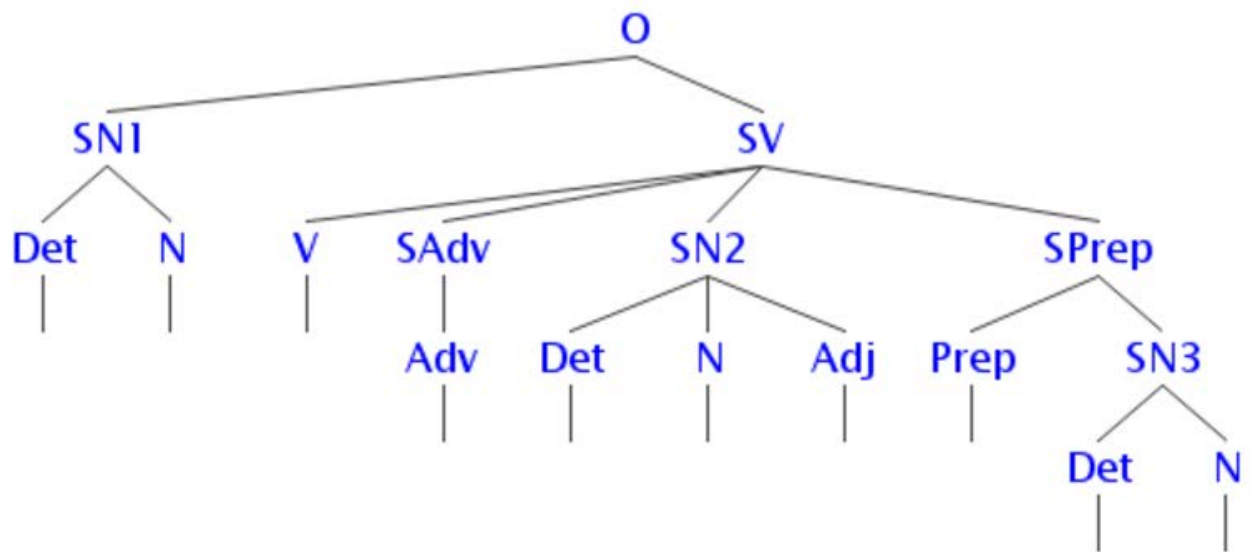
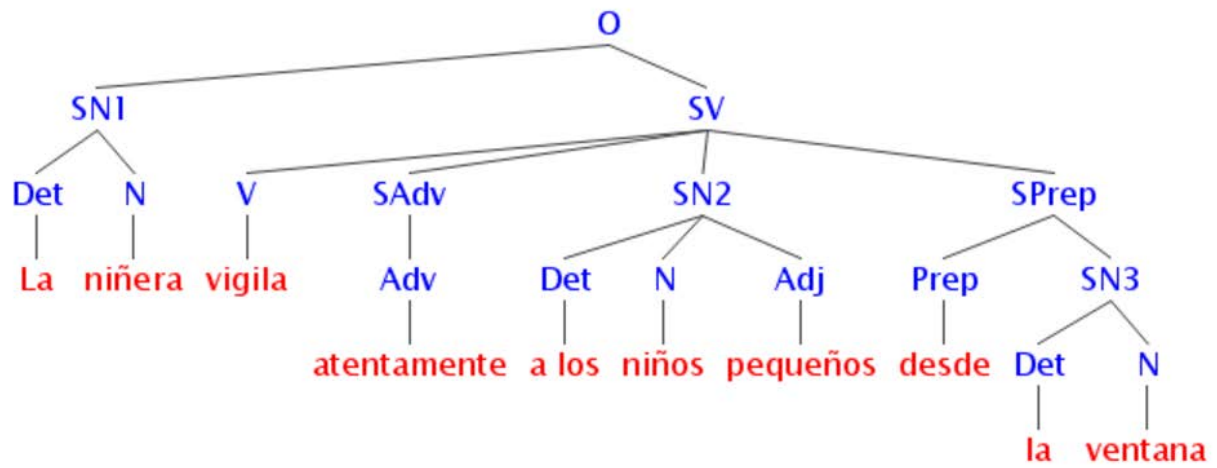

8. Hablar con usted es siempre un enorme placer.

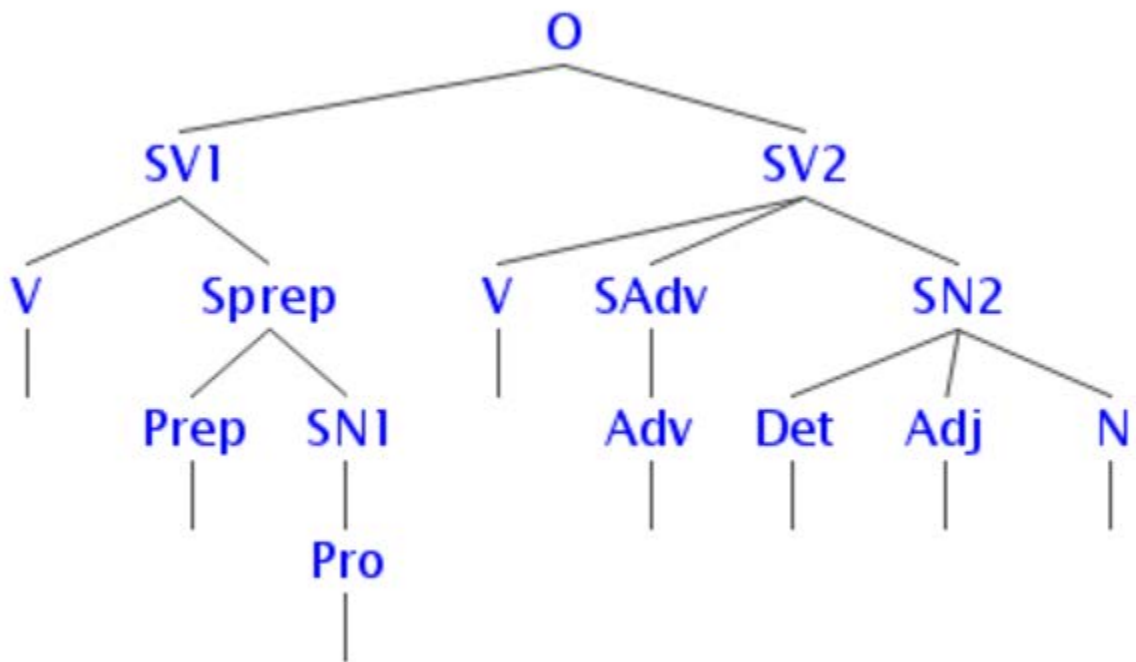
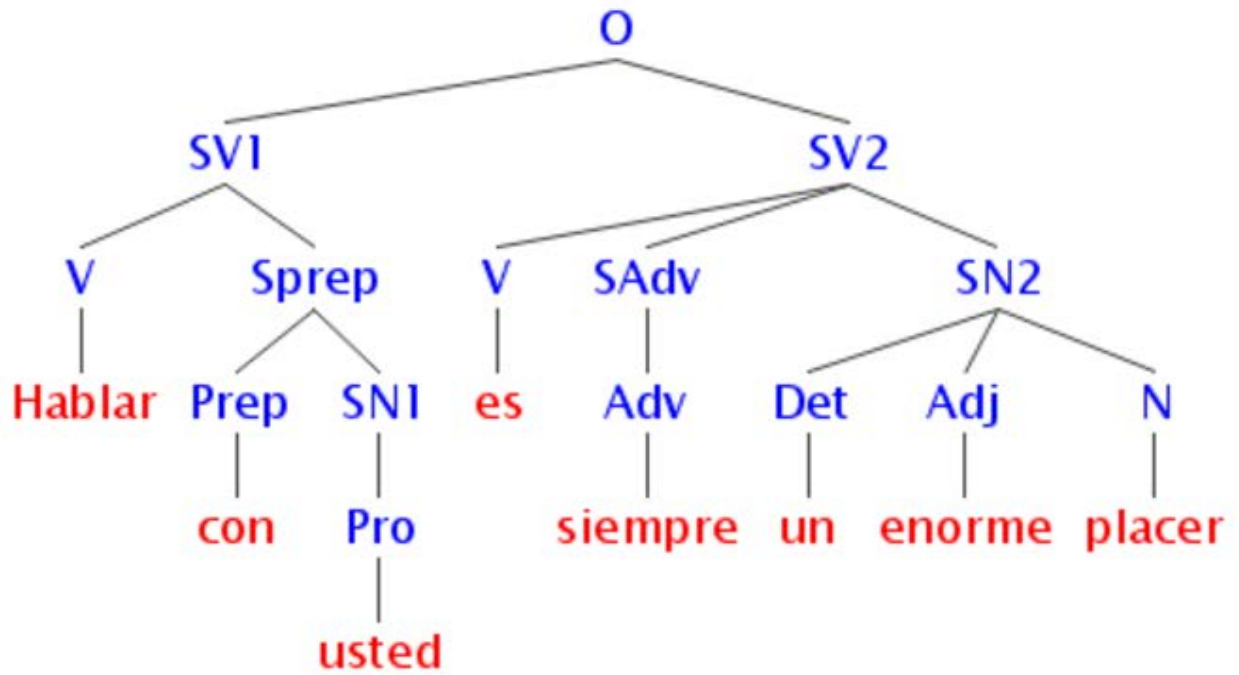

9. Por tu amor iría al fin del mundo.

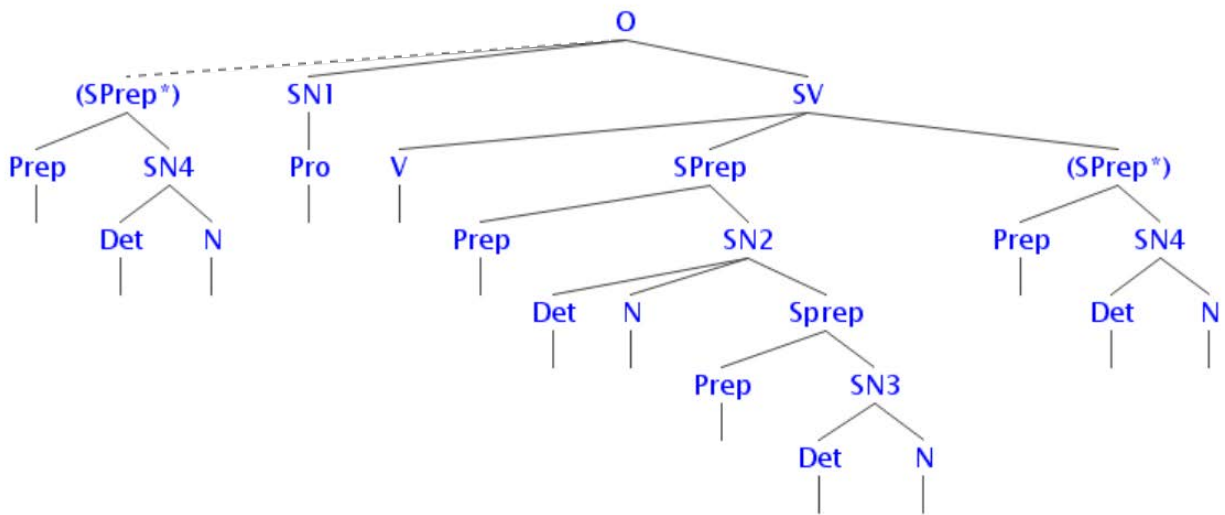
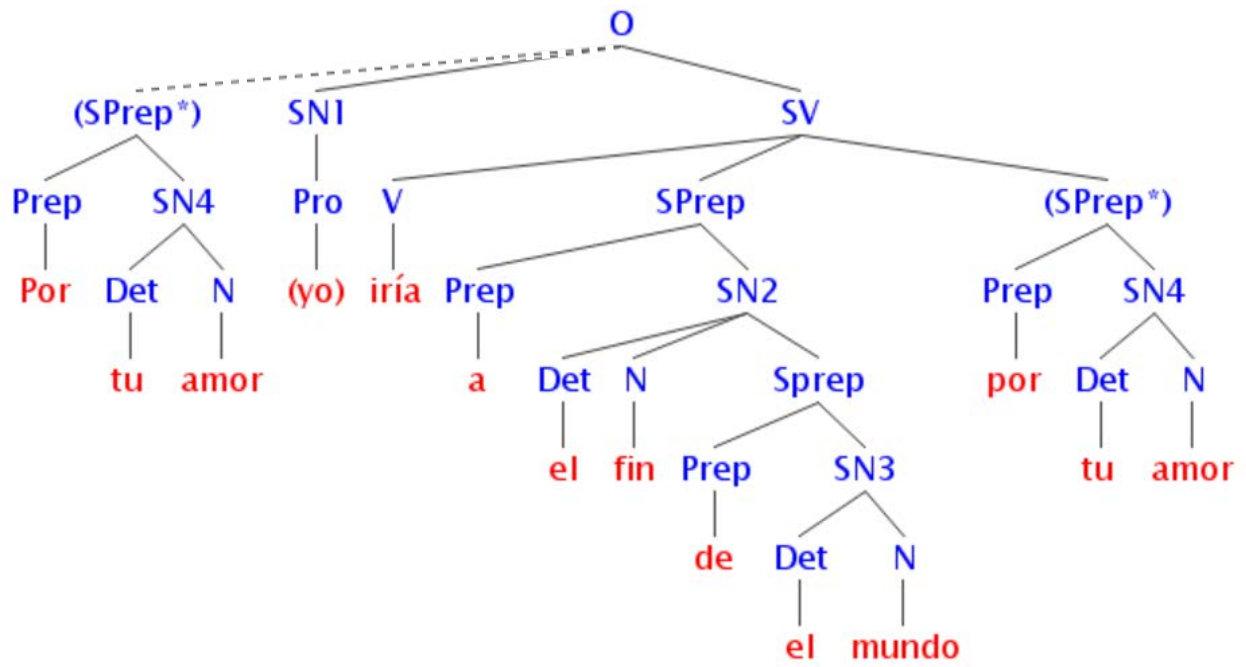

10. Nunca he dudado de la palabra de un buen amigo.

